



## DEUTSCH H94 Series Filter Connectors

### MIL-DTL-38999 SERIES IV



MIL-DTL-38999 Series IV connectors are subminiature, environmental-class connectors with high and medium-density insert arrangements. The breech lock coupling mechanism, which requires 1/4 turn for mating, makes them well suited for blind mating and high-vibration applications. Available with crimp contacts, PC tails, solder cups and headers, they feature various plating options available and five keying options.

#### SPECIFICATIONS

##### MATING COMPATIBILITY

- MIL-DTL-38999 connectors
- DEUTSCH DIV connectors

##### RELIABLE

- Breech lock coupling, one-quarter turn
- 100% scoop proof
- RFI shell-to-shell continuity

##### VERSATILE

- Wide range of connector shell configurations
- Configurable filter topologies

##### DESIGNED FOR HARSH ENVIRONMENTS

- Vibration and shock
- Temperature extremes
- High humidity
- Altitude
- Salt spray

##### Environmental

- **Temperature Range:** -55°C to 125°C
- **Physical Shock:** Typical to EIA-364-27 test condition C
- **Vibration:** Typical to EIA-364-28
- **Fungus Resistance:** Based on MIL-STD-810
- **Fluid Immersion:** Typically tested to EIA-364-10
- **Salt Spray:** Typically based on EIA/ECA-364-26
- **Humidity:** Typically EIA-364-31 test method IV
- **Durability:** 1500 cycles for Classes J and M and 500 cycles for all other connectors as per 38999 spec

##### Electrical

- **Grounded Line Resistance (Typ.):** 15 mΩ
- **Insulation Resistance (Typ.):** >5 GΩ
- **Dielectric Withstand (Typ.):** <5 μA
- **DWV:** up to 2000 VDC
- **Working Voltage:** up to 2000 VDC
- **Typical Test Specifications Used:**  
MIL-STD-810: Test Method Standard  
MIL-STD-202: Electrical & Electronic Component Parts  
RTCA DO-160: Test Procedures for Airborne Equipment  
EIA-364: Electrical Connector & Socket Test Procedures

##### Filtering

- **Capacitance Range:** 20 pF to 4 μF
- **Capacitance Tolerance:** Typically 20%
- **Unfiltered Line Cap (Typ.):** 15 pF
- **Filtering Topologies:** L, C, LC, CL, Pi, T, Double T

Transient protection available as per RTCA Publication DO 160 (see page 55).



# DEUTSCH H94 Series Filter Connectors

## MIL-DTL-38999 SERIES IV

### Jam Nut Receptacle Connectors

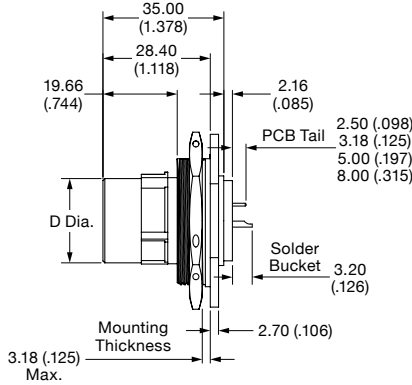

Single Flange

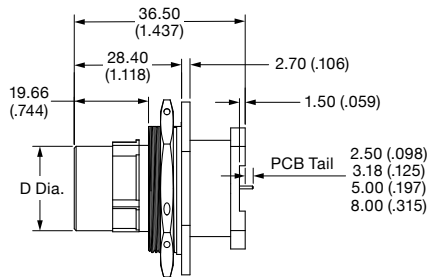

Double Flange

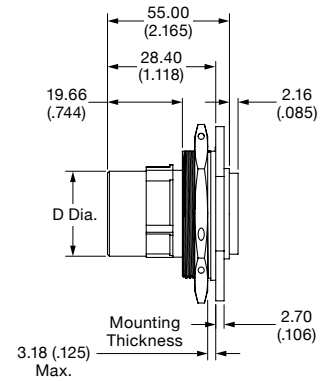

Single Flange, Crimp Contacts

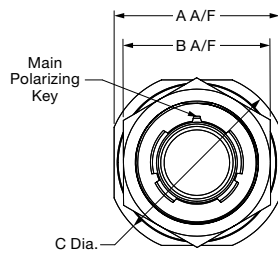

Front View

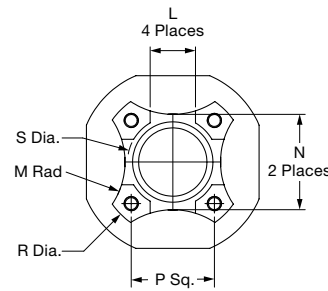

Double Flange Footprint

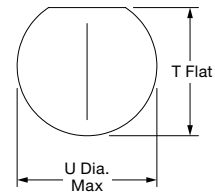

Recommended Panel Cutout

Shell Size	A A/F Max.	B A/F Max.	C Dia. Max.	D Dia. Max.	L Ref.	M Rad Ref.	N Ref.	P Sq.	R Dia.	S Dia.	Mounting Dims	
											T Flat	U Dia.
11	35.40 (1.394)	32.00 (1.260)	38.60 (1.520)	12.93 (0.509)	8.00 (0.315)	9.00 (0.354)	15.50 (0.610)	14.00 (0.551)	27.06 (1.065)	14.34 (0.565)	24.26 (0.955)	25.65 (1.010)
13	38.60 (1.520)	36.00 (1.417)	41.70 (1.642)	16.10 (0.634)	8.00 (0.315)	12.00 (0.472)	18.65 (0.734)	17.00 (0.669)	32.06 (1.262)	17.42 (0.686)	27.56 (1.085)	28.83 (1.135)
15	41.70 (1.642)	41.00 (1.614)	44.90 (1.768)	19.28 (0.759)	12.00 (0.472)	18.00 (0.709)	22.00 (0.866)	19.00 (0.748)	35.06 (1.380)	20.72 (0.816)	30.73 (1.210)	32.01 (1.260)
17	45.70 (1.799)	41.00 (1.614)	49.70 (1.957)	22.48 (0.885)	12.00 (0.472)	20.00 (0.787)	25.25 (0.994)	22.00 (0.866)	39.06 (1.538)	23.89 (0.941)	33.91 (1.335)	35.18 (1.385)
19	48.50 (1.909)	46.00 (1.811)	51.70 (2.035)	25.63 (1.009)	16.00 (0.630)	22.00 (0.866)	28.40 (1.118)	25.00 (0.984)	42.06 (1.656)	26.43 (1.041)	37.08 (1.460)	38.35 (1.510)
21	51.70 (2.035)	50.00 (1.968)	54.80 (2.157)	28.80 (1.134)	16.00 (0.630)	22.00 (0.866)	31.55 (1.242)	27.00 (1.063)	45.06 (1.774)	29.58 (1.165)	40.26 (1.585)	41.53 (1.635)
23	54.80 (2.157)	50.00 (1.968)	58.00 (2.283)	31.98 (1.259)	16.00 (0.630)	22.00 (0.866)	34.50 (1.358)	29.00 (1.142)	48.06 (1.892)	32.76 (1.290)	43.42 (1.709)	44.70 (1.760)
25	58.00 (2.283)	55.00 (2.165)	61.20 (2.409)	35.15 (1.384)	16.00 (0.630)	24.00 (0.945)	37.30 (1.469)	31.00 (1.221)	51.06 (2.010)	35.83 (1.411)	46.61 (1.835)	47.88 (1.885)

See page 29 for insert arrangements and back cover for configuration sheet.



# DEUTSCH H94 Series Filter Connectors

## MIL-DTL-38999 SERIES IV

### Square Flange Receptacle Connectors

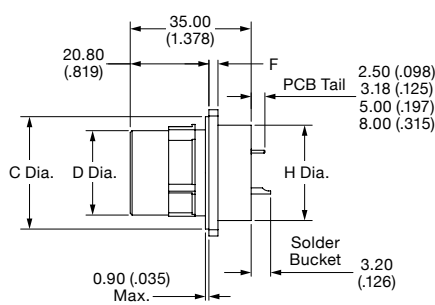

Single Flange

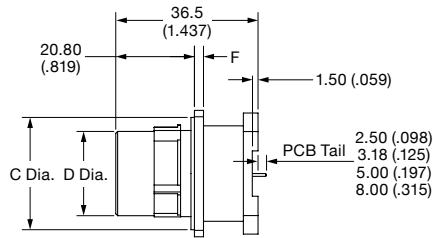

Double Flange

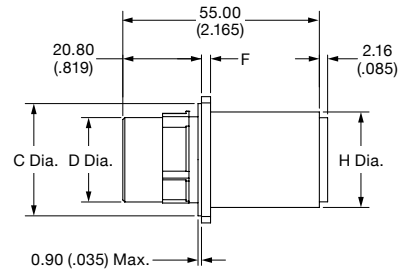

Single Flange, Crimp Contacts

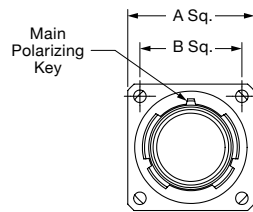

Front View

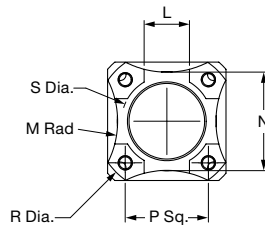

Double Flange Footprint

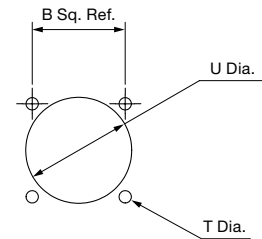

Square Flange Mounting

Shell Size	A Sq. Max.	B Sq.	C Dia. Max.	D Dia. Max.	F Max.	H Dia. Max.	L Ref.	M Rad Ref.	N Ref.	P Sq.	R Dia.	S Dia.	Mounting Holes	
													T Dia.	U Dia. Min.
11	26.70 (1.051)	20.62 (0.812)	20.15 (0.793)	12.93 (0.509)		15.67 (0.616)	8.00 (0.315)	9.00 (0.354)	15.50 (0.610)	14.00 (0.551)	27.06 (1.065)	14.34 (0.565)		20.22 (0.796)
13	29.10 (1.146)	23.02 (0.906)	23.35 (0.919)	16.10 (0.634)		18.85 (0.742)	8.00 (0.315)	12.00 (0.472)	18.65 (0.734)	17.00 (0.669)	32.06 (1.262)	17.42 (0.686)		23.42 (0.922)
15	31.50 (1.240)	24.62 (0.970)	26.52 (1.044)	19.28 (0.759)	2.60 (0.102)	22.22 (0.874)	12.00 (0.472)	18.00 (0.709)	22.00 (0.866)	19.00 (0.748)	35.06 (1.380)	20.72 (0.816)	3.25 (0.128)	26.59 (1.047)
17	33.90 (1.335)	26.98 (1.062)	29.72 (1.170)	22.48 (0.885)		25.45 (1.001)	12.00 (0.472)	20.00 (0.787)	25.25 (0.994)	22.00 (0.866)	39.06 (1.538)	23.89 (0.941)		30.96 (1.219)
19	37.10 (1.461)	29.36 (1.156)	32.87 (1.294)	25.63 (1.009)		28.57 (1.125)	16.00 (0.630)	22.00 (0.866)	28.40 (1.118)	25.00 (0.984)	42.06 (1.656)	26.43 (1.041)		32.94 (1.297)
21	40.20 (1.583)	31.76 (1.250)	36.05 (1.419)	28.80 (1.134)		31.75 (1.250)	16.00 (0.630)	22.00 (0.866)	31.55 (1.242)	27.00 (1.063)	45.06 (1.774)	29.58 (1.165)		36.12 (1.422)
23	43.40 (1.709)	34.92 (1.374)	39.22 (1.544)	31.98 (1.259)	3.40 (0.134)	34.72 (1.367)	16.00 (0.630)	22.00 (0.866)	34.50 (1.358)	29.00 (1.142)	48.06 (1.892)	32.76 (1.290)	3.91 (0.154)	39.29 (1.547)
25	46.60 (1.835)	38.10 (1.500)	42.40 (1.669)	35.15 (1.384)		37.5 (1.476)	16.00 (0.630)	24.00 (0.945)	37.30 (1.469)	31.00 (1.221)	51.06 (2.010)	35.83 (1.411)		42.47 (1.672)

See page 29 for insert arrangements and back cover for configuration sheet.



# DEUTSCH H94 Series Filter Connectors

## MIL-DTL-38999 SERIES IV

### Plug Connectors

Shell Size	A Dia. Max	B Dia. Max	V Thread (0-6g 0.100R)
11	26.60 (1.047)	19.70 (0.775)	M15 x 1.0
13	31.00 (1.220)	22.90 (0.901)	M18 x 1.0
15	34.20 (1.346)	26.40 (1.039)	M22 x 1.0
17	37.40 (1.472)	29.2 (1.149)	M25 x 1.0
19	40.20 (1.583)	32.4 (1.275)	M28 x 1.0
21	43.30 (1.704)	35.60 (1.401)	M31 x 1.0
23	46.50 (1.831)	38.8 (1.527)	M34 x 1.0
25	49.700 (1.957)	41.90 (1.649)	M37 x 1.0

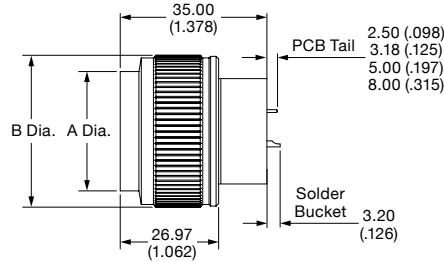

PCB/Solder Bucket Contacts

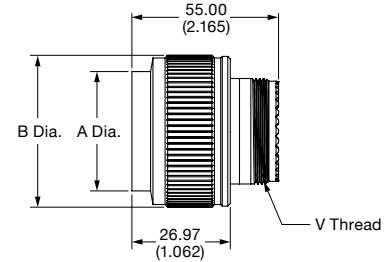

Crimp Contacts

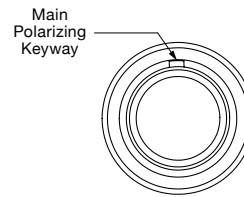

Front View

### Keying Options

(Viewed from Mating Face of the Receptacle Connector)

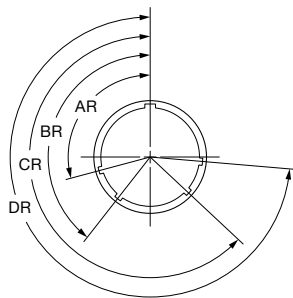

Shell Size	Key Position	Polarization (Degrees)			
		AR	BR	CR	DR
9	N	105	140	215	265
	A	102	132	248	320
	B	80	118	230	312
	C	35	140	205	275
	D	64	155	234	304
11, 13, 15	E	91	131	197	240
	N	95	141	208	236
	A	113	156	182	292
	B	90	145	195	252
	C	53	156	220	255
17, 19	D	119	146	176	298
	E	51	141	184	242
	N	80	142	196	293
	A	135	170	200	310
	B	49	169	200	244
21, 23, 25	C	66	140	200	257
	D	62	145	180	280
	E	79	153	197	272
	N	80	142	196	293
	A	135	170	200	310
21, 23, 25	B	49	169	200	244
	C	66	140	200	257
	D	62	145	180	280
	E	79	153	197	272

See page 29 for insert arrangements and back cover for configuration sheet.



## Insert Arrangements

- **Filter Connector Series:** H91, H92, H93, H94, HDJ, AS
- **Industry Specification:** MIL-DTL-38999
- **Insert Arrangement Specification:** MIL-STD-1560
- **Notes:** H91, H92, H93, H94 connectors use odd numbers for shell sizes  
 HDJ and AS connectors use even numbers for shell sizes  
 Shaded rows are TE-specific configurations not covered in MIL-STD-1560

Shell Size	Arrangement	Contact Size and Type													
		0	4	8 Twin	8 Coax	8 Power	12 Twin	12 Coax	10	12	16	20	22	23	24
9 (8)	09-98 (08-98)	–	–	–	–	–	–	–	–	–	–	3	–	–	–
	09-35 (08-35)	–	–	–	–	–	–	–	–	–	–	–	6	–	–
	09-07 (08-07)	–	–	–	–	–	–	–	–	–	–	–	–	7	–
	09-23 (08-23)	–	–	–	–	–	–	–	–	–	–	–	–	–	9
	09-11 (08-11)	–	–	–	–	–	–	–	–	–	–	–	–	–	–
11 (10)	11-02 (10-02)	–	–	–	–	–	–	–	–	–	2	–	–	–	–
	11-04 (10-04)	–	–	–	–	–	–	–	–	–	–	4	–	–	–
	11-05 (10-05)	–	–	–	–	–	–	–	–	–	–	–	5	–	–
	11-98 (10-98)	–	–	–	–	–	–	–	–	–	–	–	6	–	–
	11-99 (10-99)	–	–	–	–	–	–	–	–	–	–	–	–	7	–
	11-35 (10-35)	–	–	–	–	–	–	–	–	–	–	–	–	13	–
	11-23 (10-23)	–	–	–	–	–	–	–	–	–	–	–	–	–	19
11-23 (10-23)	–	–	–	–	–	–	–	–	–	–	–	–	–	–	23
13 (12)	13-04 (12-04)	–	–	–	–	–	–	–	–	–	4	–	–	–	–
	13-08 (12-08)	–	–	–	–	–	–	–	–	–	–	8	–	–	–
	13-98 (12-98)	–	–	–	–	–	–	–	–	–	–	–	10	–	–
	13-35 (12-35)	–	–	–	–	–	–	–	–	–	–	–	–	22	–
	13-23 (12-23)	–	–	–	–	–	–	–	–	–	–	–	–	–	32
	13-41 (12-41)	–	–	–	–	–	–	–	–	–	–	–	–	–	–
15 (14)	15-05 (14-08)	–	–	–	–	–	–	–	–	–	5	–	–	–	–
	15-97 (14-97)	–	–	–	–	–	–	–	–	–	4	8	–	–	–
	15-15 (14-15)	–	–	–	–	–	–	–	–	–	1	14	–	–	–
	15-18 (14-18)	–	–	–	–	–	–	–	–	–	–	18	–	–	–
	15-19 (14-18)	–	–	–	–	–	–	–	–	–	–	19	–	–	–
	15-26 (14-26)	–	–	–	–	–	–	–	–	–	2	–	24	–	–
	15-35 (14-35)	–	–	–	–	–	–	–	–	–	–	–	–	37	–
	15-23 (14-23)	–	–	–	–	–	–	–	–	–	–	–	–	–	55
	15-64 (14-64)	–	–	–	–	–	–	–	–	–	–	–	–	–	–
17 (16)	17-22 (16-22)	–	–	2	–	–	–	–	–	2	–	–	–	–	–
	17-06 (16-06)	–	–	–	–	–	–	–	–	6	–	–	–	–	–
	17-08 (16-08)	–	–	–	–	–	–	–	–	–	8	–	–	–	–
	17-11 (16-11)	–	–	2	1	–	–	–	–	–	8	–	–	–	–
	17-19 (16-19)	–	–	–	–	–	–	–	–	–	4	11	4	–	–
	17-20 (16-20)	–	–	–	–	–	–	–	–	4	–	–	16	–	–
	17-99 (16-99)	–	–	–	–	–	–	–	–	–	2	21	–	–	–
	17-24 (16-24)	–	–	–	–	2	–	–	–	–	–	–	22	–	–
	17-26 (16-26)	–	–	–	–	–	–	–	–	–	–	26	–	–	–
	17-03 [17-02] (16-03)	–	–	–	–	–	–	–	–	–	–	–	–	38	–
	17-35 (16-35)	–	–	–	–	–	–	–	–	–	–	–	–	55	–
	17-23 (16-23)	–	–	–	–	–	–	–	–	–	–	–	–	–	73



## Insert Arrangements

Shell Size	Arrangement	Contact Size and Type													
		0	4	8 Twin	8 Coax	8 Power	12 Twin	12 Coax	10	12	16	20	22	23	24
19 (18)	19-11 (18-11)	—	—	—	—	—	—	—	—	—	11	—	—	—	—
	19-19 [19-18] 18-18	—	—	4	—	—	—	—	—	—	—	—	14	—	—
	19-28 (18-28)	—	—	—	—	—	—	—	—	—	2	26	—	—	—
	19-32 (18-32)	—	—	—	—	—	—	—	—	—	—	32	—	—	—
	19-35 (18-35)	—	—	—	—	—	—	—	—	—	—	—	66	—	—
	19-23 (18-23)	—	—	—	—	—	—	—	—	—	—	—	—	88	—
	19-118 (18-118)	—	—	—	—	—	—	—	—	—	—	—	—	—	118
21 (20)	21-76 [21-75] (20-76)	—	—	4	—	—	—	—	—	—	—	—	—	—	—
	21-48 (20-48)	—	—	—	—	4	—	—	—	—	—	—	—	—	—
	21-11 (20-11)	—	—	—	—	—	—	—	11	—	—	—	—	—	—
	21-16 (20-16)	—	—	—	—	—	—	—	—	16	—	—	—	—	—
	21-20 (20-20)	—	—	2	—	—	—	—	—	—	18	—	—	—	—
	21-39 (20-39)	—	—	—	—	—	—	—	—	—	2	37	—	—	—
	21-41 (20-41)	—	—	—	—	—	—	—	—	—	—	41	—	—	—
	21-35 (20-35)	—	—	—	—	—	—	—	—	—	—	—	79	—	—
21-23 (20-23)	—	—	—	—	—	—	—	—	—	—	—	—	121	—	
23 (22)	23-100 (22-100)	1	—	—	—	—	—	—	—	—	—	—	—	—	—
	23-24320 (22-24320)	—	2	—	—	—	—	—	—	—	—	3	—	—	—
	23-68 (22-68)	—	—	—	—	6	—	—	—	—	—	—	—	—	—
	23-06 (22-06)	—	—	6	—	—	—	—	—	—	—	—	—	—	—
	23-21 (22-21)	—	—	—	—	—	—	—	—	21	—	—	—	—	—
	23-54 (22-54)	—	—	—	—	—	—	—	4	9	—	40	—	—	—
	23-53 (22-53)	—	—	—	—	—	—	—	—	—	53	—	—	—	—
	23-55 (22-55)	—	—	—	—	—	—	—	—	—	55	—	—	—	—
	23-63 (22-63)	—	—	—	—	—	—	—	4	4	—	49	—	—	—
23-35 (22-35)	—	—	—	—	—	—	—	—	—	—	100	—	—	—	
23-23 (22-23)	—	—	—	—	—	—	—	—	—	—	—	—	151	—	
25 (24)	25-44420 (24-44420)	—	4	—	—	—	—	—	—	—	—	4	—	—	—
	25-08 (24-08)	—	8	—	—	—	—	—	—	—	—	—	—	—	—
	25-11 (24-11)	—	—	—	—	—	—	—	9	—	—	2	—	—	—
	25-24 (24-24)	—	—	—	—	—	—	—	—	12	12	—	—	—	—
	25-21 [25-20] (24-21)	—	—	3	—	—	—	4	—	—	13	10	—	—	—
	25-19 (24-19)	—	—	—	—	—	—	—	—	19	—	—	—	—	—
	25-29 (24-29)	—	—	—	—	—	—	—	—	—	29	—	—	—	—
	25-37 (24-37)	—	—	—	—	—	—	—	—	—	37	—	—	—	—
	25-17 (24-17)	—	—	6	—	—	—	—	—	—	—	—	36	—	—
	25-43 (24-43)	—	—	—	—	—	—	—	—	—	20	23	—	—	—
	25-47 [25-46] (24-47)	—	—	—	2	—	—	—	—	—	4	40	—	—	—
	25-91 [25-90] (24-91)	—	—	2	—	—	—	—	—	—	4	40	—	—	—
	25-04 (24-04)	—	—	—	—	—	—	—	—	—	8	48	—	—	—
	25-35 (24-35)	—	—	—	—	—	—	—	—	—	—	—	128	—	—
	25-61 (24-61)	—	—	—	—	—	—	—	—	—	—	61	—	—	—
25-09 [25-07] (24-09)	—	—	2	—	—	—	—	—	—	—	—	97	—	—	
25-23 (24-23)	—	—	—	—	—	—	—	—	—	—	—	—	187	—	